



PLANET
PLASTİK ELEKTRİK

2024
CATALOGUE



PLANET
PLASTİK ELEKTRİK

HAKKIMIZDA

Planet Plastik A.Ş., 2023 yılında kurulmuş ve faaliyetlerine başladığı günden itibaren, PVC kablo kanalları, PVC spiral borular ve çeşitli elektrik malzemeleri üretimi konusunda 20 yıllık deneyim, birikim ve tecrübesini kullanarak, gün geçtikçe kendini geliştirmiştir. 2.500 metrekarelik modern bir fabrikada faaliyet gösteren şirketimiz, Türkiye genelinde ve dünya pazarında büyük hedeflere sahip yenilikçi bir firmadır. Müşterilerimize en yüksek kalitede ürünler sunmayı ilke edinerek, en son teknolojiye sahip üretim makinelerle üretim yapmaktadır.

Ekip ve firma olarak Kalite bizim önceliğimizdir. Hedeflerimize doğru ilerlerken, deneyimli satış ekibimiz sürekli olarak pazar araştırmaları yapmakta ve değişen pazar koşullarına göre müşterilerimizin talepleri ve ihtiyaçları doğrultusunda AR-GE çalışmaları yapmaktadır. Kendi kalıphanelerimizde kalıp tasarımlarını gerçekleştirerek üretim aşamasına geçiyor ve müşterilerimize daha geniş bir ürün yelpazesi sunmayı hedefliyoruz. Müşteri memnuniyetini en üst seviyede tutmak için sürekli olarak ürünlerimizi geliştirmek ve yenilikçi çözümler sunmak için çaba gösteriyoruz.

Planet Plastik A.Ş. olarak, sektörde öncü bir konumda olmayı sürdürmek ve müşterilerimize güvenilir ve kaliteli ürünler sunmaya devam etmek için çalışmalarımızı sürdürüyoruz.

ABOUT US

Planet Plastik A.Ş. was established in 2023 and since the day it started its activities, PVC cable trays, PVC 20 years of experience in the production of spiral pipes and various electrical materials He has improved himself day by day. Operating in a modern factory of 2,500 square meters, our company, across Türkiye and is an innovative company with great goals in the world market. We offer our customers the highest quality products By adopting the principle of presenting, it produces with the latest technology production machines.

As a team and company Quality is our priority. As we move towards our goals, experienced sales'xD; our team is constantly on the market We conduct researches and in line with the demands and needs of our customers according to the changing market conditions'xD; It carries out R&D studies. Production by realizing mold designs in our own molding houses'xD; We aim to offer a wider range of products to our customers. Customer satisfaction We strive to continuously improve our products and provide innovative solutions to keep them at the highest level. we show. As Planet Plastik A.Ş., to maintain a leading position in the sector and reliable to our customers and we continue our efforts to continue to offer quality products.

CABLE TRUNKINGS

KABLO KANALLARI

**KABLOLARINIZ
GÜVENDE**

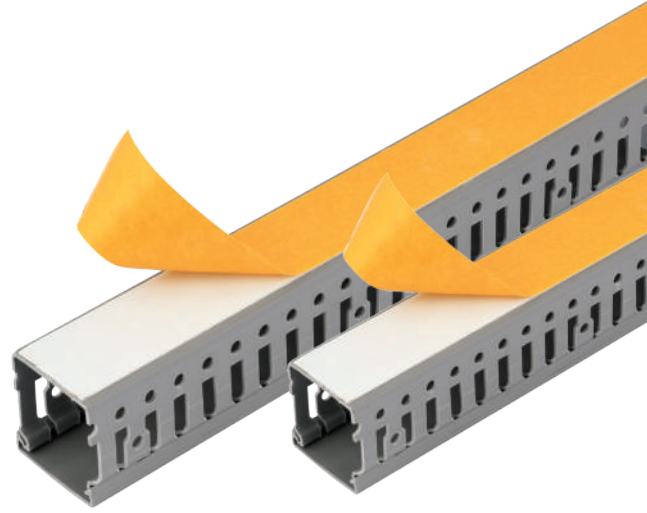
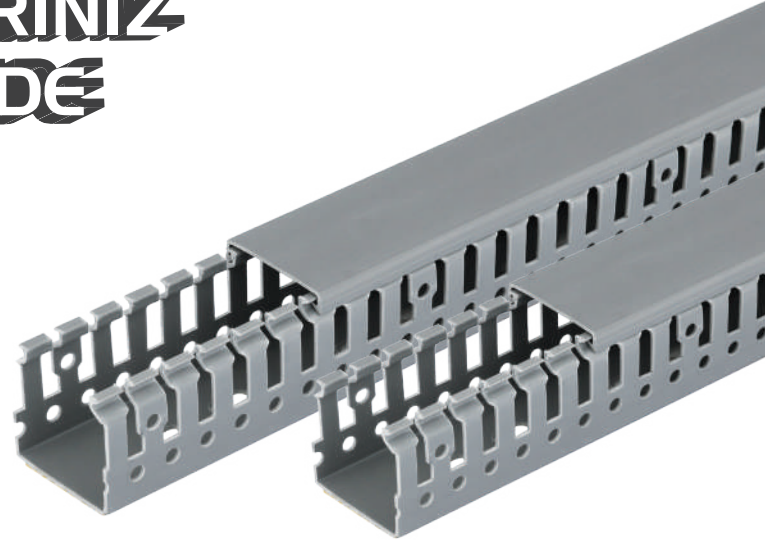

Alev Almaz
Unflammable



**Darbelere
Dayanıklı**
Impact Resistant

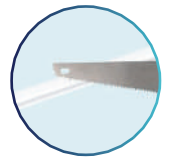

**İstenilen Ebatta
Kesilebilme Kolaylığı**
Ease of Cutting to
Desire Size

PVC KABLO KANALLARI KUTULU PVC CABLE TRUNKINGS BOX



Alev Almaz
Unflammmable



KOD CODE	ÜRÜN PRODUCT	AMBALAJ MİKTARI PACKAGE METER
PLNK-1212	12 x 12 Kablo Kanalı	450
PLNK-1510	15 x 10 Kablo Kanalı	440
PLNK-1616	16 x 16 Kablo Kanalı	304
PLNK-2010	20 x 10 Kablo Kanalı	330
PLNK-2516	25 x 16 Kablo Kanalı	200
PLNK-2525	25 x 25 Kablo Kanalı	130
PLNK-4016	40 x 16 Kablo Kanalı	116
PLNK-4025	40 x 25 Kablo Kanalı	80
PLNK-4040	40 x 40 Kablo Kanalı	72
PLNK-6040	60 x 40 Kablo Kanalı	48
PLNK-6060	60 x 60 Kablo Kanalı	40
PLNK-8040	80 x 40 Kablo Kanalı	40
PLNK-8060	80 x 60 Kablo Kanalı	32
PLNK-1040	100 x 40 Kablo Kanalı	36
PLNK-1060	100 x 60 Kablo Kanalı	24

YAPIŞKANLI PVC BANTLI KABLO KANALLARI KUTULU
ADHESIVE CABLE TRUNKINGS BOX



Alev Almaz
Unflammable

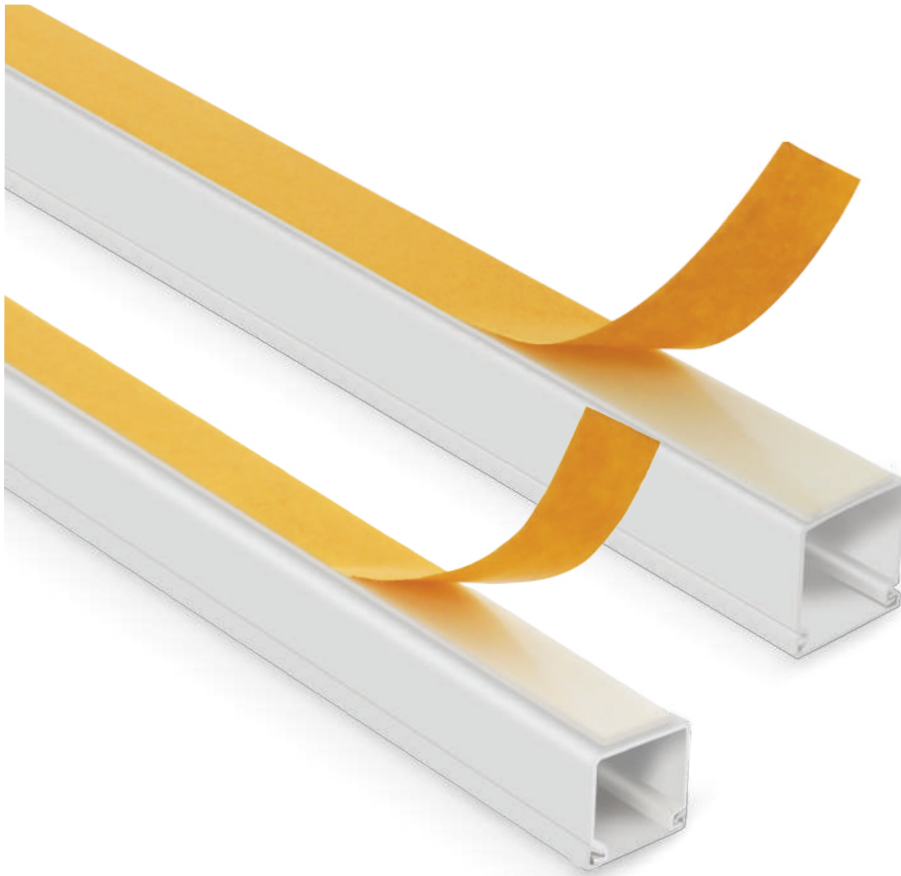

KOD CODE	ÜRÜN PRODUCT	AMBALAJ MİKTARI PACKAGE METER
PLNB-1212	12 x 12 Bantlı Kablo Kanalı	450
PLNB-1510	15 x 10 Bantlı Kablo Kanalı	440
PLNB-1616	16 x 16 Bantlı Kablo Kanalı	304
PLNB-2010	20 x 10 Bantlı Kablo Kanalı	330
PLNB-2516	25 x 16 Bantlı Kablo Kanalı	200
PLNB-2525	25 x 25 Bantlı Kablo Kanalı	130
PLNB-4016	40 x 16 Bantlı Kablo Kanalı	116
PLNB-4025	40 x 25 Bantlı Kablo Kanalı	80
PLNB-4040	40 x 40 Bantlı Kablo Kanalı	72
PLNB-6040	60 x 40 Bantlı Kablo Kanalı	48
PLNB-6060	60 x 60 Bantlı Kablo Kanalı	40

100 x 50 İÇTEN KAPAKLI KABLO KANALI
100 x 50 INSIDE COVER CABLE TRUNKING



Alev Almaz
Unflammmable



ARA BÖLME
TAKILABİLİR

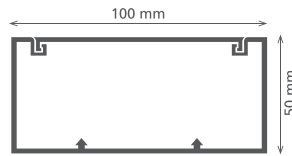

100 x 50

Ürün Kodu - Product Code	PLNK-10050
Uzunluk - Length	2 mt
Kesit - Section	100 x 50
Ambalaj Miktarı (m) - Package Total (m)	20 Mt.
Ambalaj Şekli - Package	Koli - Carton Box
Fiyat Mt - Price Mt	186,36 ₺

100 x 50 KABLO KANALI AKSESUARLARI

100 X 50 INSIDE COVER CABLE TRUNKING ACCESSORIES



KOD CODE	ÜRÜN PRODUCT	AMBALAJ MİKTARI PACKAGE METER
PLN-AKS-01	Ara Bölme Divider	100 mt
PLN-AKS-02	L Bağlantı Elemanı 90° 90° Corner Piece	12
PLN-AKS-03	Dış Köşe (Hareketli) External Corner	10
PLN-AKS-04	İç Köşe (Hareketli) Internal Corner	12
PLN-AKS-05	T Bağlantı Elemanı T Branches	12
PLN-AKS-06	Sonlandırma Kapağı End Cover	24
PLN-AKS-07	Kanal Birleştirme Parçası Junction Piece	24
PLN-AKS-08	Tekli 45 x 45 Priz Montaj Seti Single Frame Cover Set For 45 x 45	12
PLN-AKS-09	İkili 45 x 45 Priz Montaj Seti Double Frame Cover Set For 45 x 45	12
PLN-AKS-010	Üçlü 45 x 45 Priz Montaj Seti Triple Frame Cover Set For 45 x 45	12
PLN-AKS-011	Dörtlü 45 x 45 Priz Montaj Seti Quadruple Frame Cover Set For 45 x 45	20
PLN-AKS-012	İngiliz Tip Tekli Priz Çerçevesi British Type Socket Frame	100
PLN-AKS-013	İngiliz Tip İkili Priz Çerçevesi British Type Double Socket Frame	100
PLN-AKS-014	45x45 Data ve Telefon Priz Kapağı Tekli 45x45 Data and Telephone Socket Single	50
PLN-AKS-015	45x45 Data ve Telefon Priz Kapağı 2'li 45x45 Data and Telephone Socket Double	50
PLN-AKS-016	Topraklı UPS Priz Single UPS Socket	50
PLN-AKS-017	Tekli Şebeke Prizi Single Grounded Socket	50

AHŞAP DESENLİ KABLO KANALLARI KUTULU WOOD PATTERNED CABLE TRUNKINGS BOX



Alev Almaz
Unflamable



Sipariş üzerine üretilir.

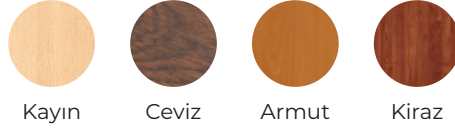

Kayın

Ceviz

Armut

Kiraz



KOD CODE	ÜRÜN PRODUCT	AMBALAJ MİKTARI PACKAGE METER
PLNBA-1212	12 x 12 Bantlı Kablo Kanalı	450
PLNBA-1510	15 x 10 Bantlı Kablo Kanalı	440
PLNBA-1616	16 x 16 Bantlı Kablo Kanalı	304
PLNBA-2010	20 x 10 Bantlı Kablo Kanalı	330
PLNBA-2516	25 x 16 Bantlı Kablo Kanalı	200
PLNBA-2525	25 x 25 Bantlı Kablo Kanalı	130
PLNBA-4016	40 x 16 Bantlı Kablo Kanalı	116
PLNBA-4025	40 x 25 Bantlı Kablo Kanalı	80
PLNBA-4040	40 x 40 Bantlı Kablo Kanalı	72
PLNBA-6040	60 x 40 Bantlı Kablo Kanalı	48
PLNBA-6060	60 x 60 Bantlı Kablo Kanalı	40

PANO TİPİ KABLO KANALLARI KUTULU SLOTTED CABLE TRUNKINGS BOX

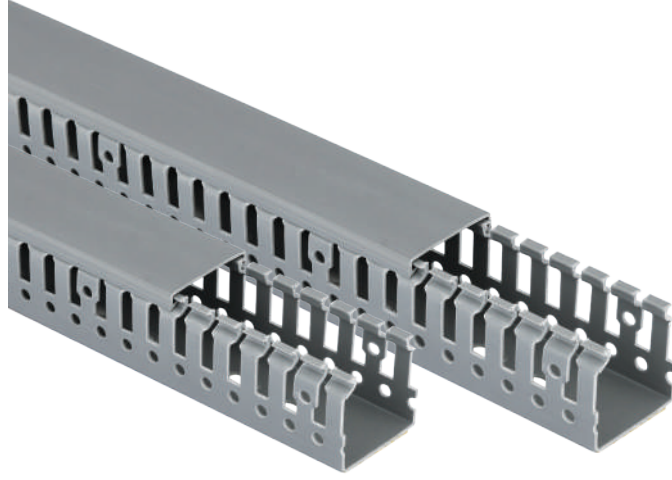

Alev Almaz
Unflamable



KOD CODE	ÜRÜN PRODUCT	AMBALAJ MİKTARI PACKAGE METER
PLNP-2525	25 x 25 Pano Tipi Kablo Kanalı	126
PLNP-2540	25 x 40 Pano Tipi Kablo Kanalı	84
PLNP-4040	40 x 40 Pano Tipi Kablo Kanalı	72
PLNP-4060	40 x 60 Pano Tipi Kablo Kanalı	48
PLNP-6060	60 x 60 Pano Tipi Kablo Kanalı	24

PANO TİPİ YAPIŞKANLI KABLO KANALLARI KUTULU SLOTTED ADHESIVE CABLE TRUNKINGS BOX

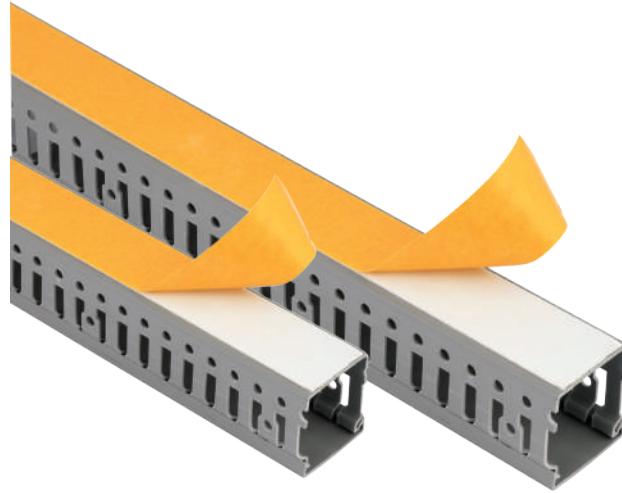

Alev Almaz
Unflamable



KOD CODE	ÜRÜN PRODUCT	AMBALAJ MİKTARI PACKAGE METER
PLNPB-2525	25 x 25 Yapışkanlı Pano Tipi Kablo Kanalı	126
PLNPB-2540	25 x 40 Yapışkanlı Pano Tipi Kablo Kanalı	84
PLNPB-4040	40 x 40 Yapışkanlı Pano Tipi Kablo Kanalı	72
PLNPB-4060	40 x 60 Yapışkanlı Pano Tipi Kablo Kanalı	48
PLNPB-6060	60 x 60 Yapışkanlı Pano Tipi Kablo Kanalı	24

BALIK SIRTI KABLO KANALLARI KUTULU OVERFLOOR CABLE TRUNKINGS BOX



Alev Almaz
Unflammable



KOD
CODE

ÜRÜN
PRODUCT

AMBALAJ MİKTARI
PACKAGE METER

PLNK-5012

50 x 12 Balık Sırtlı Kablo Kanalı

60

PLNK-7020

70 x 20 Balık Sırtlı Kablo Kanalı

28

PLNK-9020

90 x 20 Balık Sırtlı Kablo Kanalı

20

YAPIŞKANLI BALIK SIRTI KABLO KANALLARI KUTULU ADHESIVE OVERFLOOR CABLE TRUNKINGS BOX



Alev Almaz
Unflammable

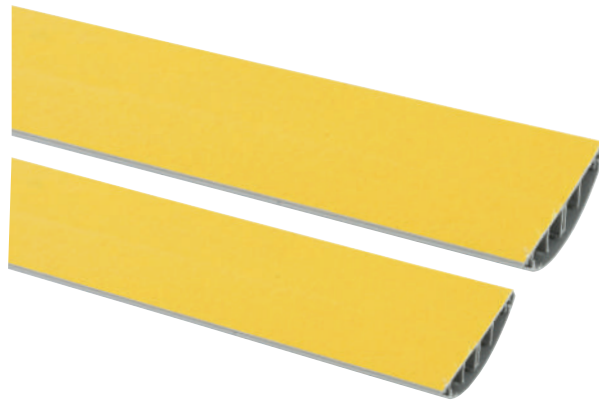

KOD
CODE

ÜRÜN
PRODUCT

AMBALAJ MİKTARI
PACKAGE METER

PLNKB-5012

50 x 12 Bantlı Balık Sırtlı Kablo Kanalı

60

PLNKB-7020

70 x 20 Bantlı Balık Sırtlı Kablo Kanalı

28

PLNKB-9020

90 x 20 Bantlı Balık Sırtlı Kablo Kanalı

20

IP 65

ABS BOARD

ABS PANO



ABS PANOLAR OPAK KAPAKLI
ABS Board

YENİ
ÜRÜN
NEW
PRODUCT

IP 65
IK 10



KOD CODE	ÜRÜN PRODUCT	AMBALAJ MİKTARI PACKAGE METER
PLN-ABS-120	200x300x120 ABS Pano	1
PLN-ABS-150	250x350x150 ABS Pano	1
PLN-ABS-170	300x400x180 ABS Pano	1
PLN-ABS-220	300x400x220 ABS Pano	1
PLN-ABS-190	350x500x190 ABS Pano	1
PLN-ABS-180	400x500x180 ABS Pano	1
PLN-ABS-210	400x500x210 ABS Pano	1
PLN-ABS-200	400x600x200 ABS Pano	1
PLN-ABS-230	500x600x230 ABS Pano	1
PLN-ABS-250	500x700x250 ABS Pano	1
PLN-ABS-280	600x800x280 ABS Pano	1

ABS PANOLAR ŞEFFAF KAPAKLI
Panel Boards With Pc Transparent Door



KOD CODE	ÜRÜN PRODUCT	AMBALAJ MİKTARI PACKAGE METER
PLN-PC-120	200x300x120 Şeffaf ABS Pano	1
PLN-PC-150	250x350x150 Şeffaf ABS Pano	1
PLN-PC-170	300x400x180 Şeffaf ABS Pano	1
PLN-PC-220	300x400x220 Şeffaf ABS Pano	1
PLN-PC-190	350x500x190 Şeffaf ABS Pano	1
PLN-PC-180	400x500x180 Şeffaf ABS Pano	1
PLN-PC-210	400x500x210 Şeffaf ABS Pano	1
PLN-PC-200	400x600x200 Şeffaf ABS Pano	1
PLN-PC-230	500x600x230 Şeffaf ABS Pano	1
PLN-PC-250	500x700x250 Şeffaf ABS Pano	1
PLN-PC-280	600x800x280 Şeffaf ABS Pano	1

BANYO ASPİRATÖRÜ BATHROOM ASPIRATOR

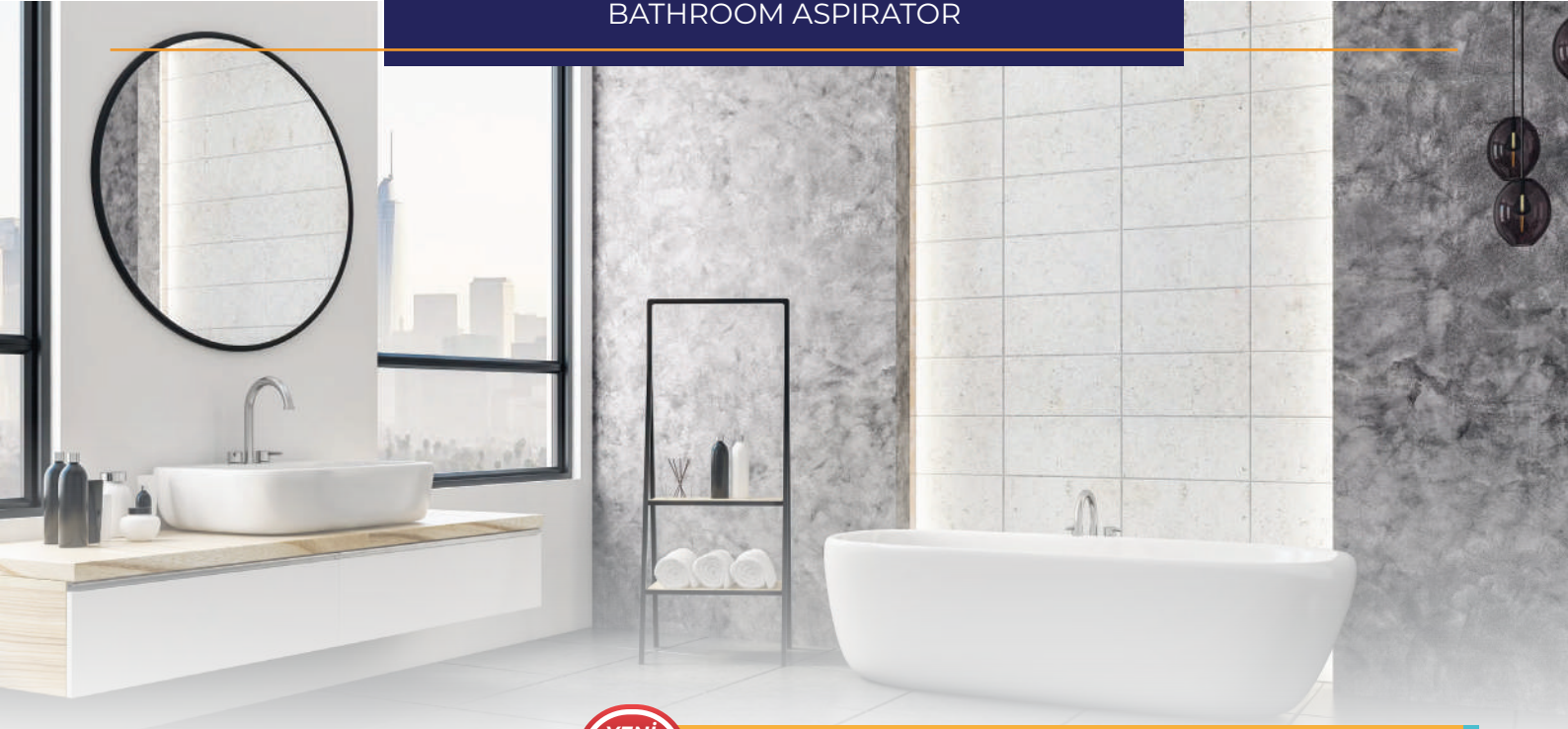

ASPİRATÖR 100MM

Ürün Kodu - Product Code

PLN-BNY-100



SÜPER
SESSİZ



Çalışma Akımı - Operation Voltage	220-240 V / 50-60 Hz
Emiş Hacmi - Airflow	100 m ³ /h
Devir Hızı - Round Speed	2250 rpm
Güç - Power	15W
Fiyat Adet - Price PCS	390,00 ₺

Kutu - Box Pcs. : 1/20



ASPİRATÖR 120MM

Ürün Kodu - Product Code

PLN-BNY-120



SÜPER
SESSİZ



Çalışma Akımı - Operation Voltage	220-240 V / 50-60 Hz
Emiş Hacmi - Airflow	120 m ³ /h
Devir Hızı - Round Speed	1900 rpm
Güç - Power	20W
Fiyat Adet - Price PCS	413,00 ₺

Kutu - Box Pcs. : 1/20



ASPİRATÖR 150MM

Ürün Kodu - Product Code

PLN-BNY-150



SÜPER
SESSİZ



Çalışma Akımı - Operation Voltage	220-240 V / 50-60 Hz
Emiş Hacmi - Airflow	150 m ³ /h
Devir Hızı - Round Speed	1800 rpm
Güç - Power	25W
Fiyat Adet - Price PCS	553,80 ₺

Kutu - Box Pcs. : 1/20

KABLO BAĞLARI CABLE TIES

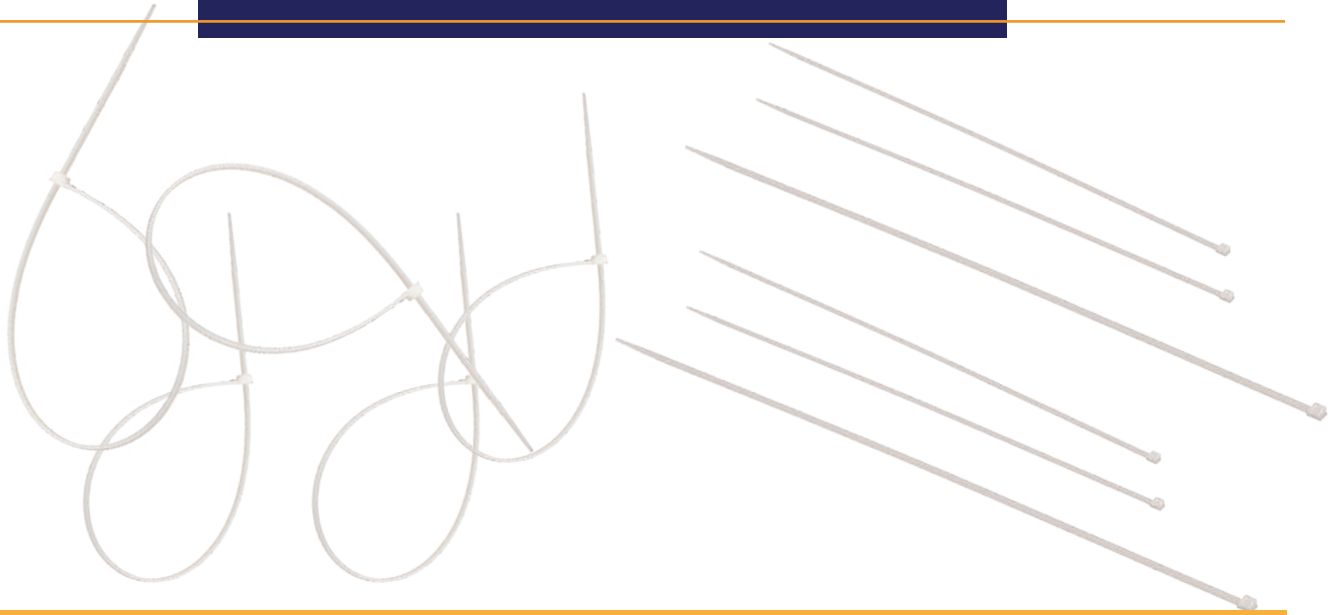

KOD CODE	EN WIDTH	BOY SIZE	POŞET BAG	KOLİ BOX	MAKSİMUM SIKMA ÇAPI (MM) MAX. CLAMPING DIAMETER (MM)	AÇILMA MUKAVEMETİ (KG) TENSILE STRENGTH (KG)
PLN-KB-25100	2,5	100	250	40.000	26	8
PLN-KB-25150	2,5	150	100	20.000	35	8
PLN-KB-25200	2,5	200	100	15.000	50	8
PLN-KB-36150	3,6	150	100	10.000	35	18
PLN-KB-36200	3,6	200	100	10.000	50	18
PLN-KB-36250	3,6	250	100	10.000	65	18
PLN-KB-36300	3,6	300	100	10.000	80	18
PLN-KB-36370	3,6	370	100	10.000	100	18
PLN-KB-48200	4,8	200	100	10.000	50	25
PLN-KB-48250	4,8	250	100	10.000	65	25
PLN-KB-48300	4,8	300	100	10.000	80	25
PLN-KB-48380	4,8	380	100	5.000	100	25
PLN-KB-48400	4,8	400	100	5.000	102	25
PLN-KB-76300	7,6	300	100	3.000	85	55
PLN-KB-76380	7,6	380	100	2.500	102	55
PLN-KB-76450	7,6	450	100	3.000	135	55
PLN-KB-76550	7,6	550	100	2.500	165	55
PLN-KB-90780	9,0	780	100	1.000	235	80
PLN-KB-90950	9,0	950	100	1.000	280	80

PVC DİŞLİ SİRİL BORU PVC THREADED SPIRAL PIPE



Klima Su Tahliye Hortumu
Air Conditioner Water Drain Hose



KOD CODE	ÜRÜN ADI PRODUCT NAME	İÇ ÇAP INSIDE	DIŞ ÇAP OUTSIDE	MT. PACK
PLN-DŞL-10	10 mm Plastik Spiral Boru	10	14.4	50
PLN-DŞL-14	14 mm Plastik Spiral Boru	14	18.6	50
PLN-DŞL-16	16 mm Plastik Spiral Boru	16	20.5	50
PLN-DŞL-20	20 mm Plastik Spiral Boru	20	24.7	50
PLN-DŞL-25	25 mm Plastik Spiral Boru	25	30.2	50
PLN-DŞL-32	32 mm Plastik Spiral Boru	32	37.4	50

Kesiksiz tek parça halinde 50 mt. sarılmaktadır.

TTR KABLOLU (BAKIR) SIVI SEVİYE FLATÖRLERİ
LIQUID LEVEL FLOATERS WITH TTR CABLE (COPPER) v**IP 68****YENİ
ÜRÜN**
NEW
PRODUCT

Kablo / Cable - TTR

Voltaj / Voltage - 220-250V

Koruma Sınıfı - IP68

Çalışma sıcaklığı / Operational Temp -25 + 80°C

KOD CODE	ÜRÜN PRODUCT	ÖLÇÜ DIMENSIONS	KOLİ ADET BOX QTY
PLNF-01	TTR Kablolu Sıvı Seviye Flatörü	1,6 mt	18
PLNF-02	TTR Kablolu Sıvı Seviye Flatörü	3 mt	18
PLNF-03	TTR Kablolu Sıvı Seviye Flatörü	5 mt	18
PLNF-04	TTR Kablolu Sıvı Seviye Flatörü	10 mt	18

ÇELİK SİRAL BORU STEEL SPIRAL PIPE CONDOIT



KOD CODE	ÜRÜN ADI PRODUCT NAME	İÇ ÇAP INSIDE	DIŞ ÇAP OUTSIDE	MT. PACK
PLN-ÇLK-9	9 mm Çelik Spiral Boru	9 mm	12.1	50
PLN-ÇLK-11	11 mm Çelik Spiral Boru	11 mm	14.1	50
PLN-ÇLK-14	14 mm Çelik Spiral Boru	14 mm	17.1	50
PLN-ÇLK-16	16 mm Çelik Spiral Boru	16 mm	19.1	50
PLN-ÇLK-18	18 mm Çelik Spiral Boru	18 mm	21.0	50
PLN-ÇLK-21	21 mm Çelik Spiral Boru	21 mm	24.0	50
PLN-ÇLK-26	26 mm Çelik Spiral Boru	26 mm	29.0	25
PLN-ÇLK-29	29 mm Çelik Spiral Boru	29 mm	31.0	25
PLN-ÇLK-32	32 mm Çelik Spiral Boru	32 mm	35.0	25
PLN-ÇLK-35	35 mm Çelik Spiral Boru	35 mm	38.0	25
PLN-ÇLK-37	37 mm Çelik Spiral Boru	37 mm	41.0	25
PLN-ÇLK-40	40 mm Çelik Spiral Boru	40 mm	43.0	25
PLN-ÇLK-42	42 mm Çelik Spiral Boru	42 mm	45.0	25
PLN-ÇLK-45	45 mm Çelik Spiral Boru	45 mm	48.0	25
PLN-ÇLK-50	50 mm Çelik Spiral Boru	50 mm	53.0	25

ÇELİK SİRAL BORU TELLİ STEEL SPIRAL PIPE WIRE



KOD CODE	ÜRÜN ADI PRODUCT NAME	İÇ ÇAP INSIDE	DIŞ ÇAP OUTSIDE	MT. FİYAT-MT PACKPRICE-MT
PLN-ÇLKT-9	9 mm Çelik Spiral Boru Telli	9 mm	12.1	50
PLN-ÇLKT-11	11 mm Çelik Spiral Boru Telli	11 mm	14.1	50
PLN-ÇLKT-14	14 mm Çelik Spiral Boru Telli	14 mm	17.1	50
PLN-ÇLKT-16	16 mm Çelik Spiral Boru Telli	16 mm	19.1	50
PLN-ÇLKT-18	18 mm Çelik Spiral Boru Telli	18 mm	21.0	50
PLN-ÇLKT-21	21 mm Çelik Spiral Boru Telli	21 mm	24.0	50
PLN-ÇLKT-26	26 mm Çelik Spiral Boru Telli	26 mm	29.0	25
PLN-ÇLKT-29	29 mm Çelik Spiral Boru Telli	29 mm	31.0	25
PLN-ÇLKT-32	32 mm Çelik Spiral Boru Telli	32 mm	35.0	25
PLN-ÇLKT-35	35 mm Çelik Spiral Boru Telli	35 mm	38.0	25
PLN-ÇLKT-37	37 mm Çelik Spiral Boru Telli	37 mm	41.0	25
PLN-ÇLKT-40	40 mm Çelik Spiral Boru Telli	40 mm	43.0	25
PLN-ÇLKT-42	42 mm Çelik Spiral Boru Telli	42 mm	45.0	25
PLN-ÇLKT-45	45 mm Çelik Spiral Boru Telli	45 mm	48.0	25
PLN-ÇLKT-50	50 mm Çelik Spiral Boru Telli	50 mm	53.0	25



PVC İZOLELİ ÇELİK SİRAL BORU

PVC INSULATED STEEL SPIRAL CONDUIT

KOD CODE	ÜRÜN ADI PRODUCT NAME	İÇ ÇAP INSIDE	DIŞ ÇAP OUTSIDE	MT. PACK
PLN-İZL-9	9 mm İzoleli Çelik Spiral Boru	9 mm	13	50
PLN-İZL-11	11 mm İzoleli Çelik Spiral Boru	11 mm	15	50
PLN-İZL-14	14 mm İzoleli Çelik Spiral Boru	14 mm	18	50
PLN-İZL-16	16 mm İzoleli Çelik Spiral Boru	16 mm	20	50
PLN-İZL-18	18 mm İzoleli Çelik Spiral Boru	18 mm	22	50
PLN-İZL-21	21 mm İzoleli Çelik Spiral Boru	21 mm	25	50
PLN-İZL-26	26 mm İzoleli Çelik Spiral Boru	26 mm	31	25
PLN-İZL-29	29 mm İzoleli Çelik Spiral Boru	29 mm	35	25
PLN-İZL-32	32 mm İzoleli Çelik Spiral Boru	32 mm	36	25
PLN-İZL-35	35 mm İzoleli Çelik Spiral Boru	35 mm	39	25
PLN-İZL-37	37 mm İzoleli Çelik Spiral Boru	37 mm	41	25
PLN-İZL-40	40 mm İzoleli Çelik Spiral Boru	40 mm	44	25
PLN-İZL-42	42 mm İzoleli Çelik Spiral Boru	42 mm	46	25
PLN-İZL-45	45 mm İzoleli Çelik Spiral Boru	45 mm	49	25
PLN-İZL-50	50 mm İzoleli Çelik Spiral Boru	50 mm	54	25



KILAVUZ TELLİ İZOLELİ ÇELİK SİRAL BORU

PVC INSULATED STEEL SPIRAL CONDUIT WITH GUIDE

KOD CODE	ÜRÜN ADI PRODUCT NAME	İÇ ÇAP INSIDE	DIŞ ÇAP OUTSIDE	MT. PACK
PLN-İZLT-9	9 mm İzoleli Çelik Spiral Boru	9 mm	13	50
PLN-İZLT-11	11 mm İzoleli Çelik Spiral Boru	11 mm	15	50
PLN-İZLT-14	14 mm İzoleli Çelik Spiral Boru	14 mm	18	50
PLN-İZLT-16	16 mm İzoleli Çelik Spiral Boru	16 mm	20	50
PLN-İZLT-18	18 mm İzoleli Çelik Spiral Boru	18 mm	22	50
PLN-İZLT-21	21 mm İzoleli Çelik Spiral Boru	21 mm	25	50
PLN-İZLT-26	26 mm İzoleli Çelik Spiral Boru	26 mm	31	25
PLN-İZLT-29	29 mm İzoleli Çelik Spiral Boru	29 mm	35	25
PLN-İZLT-32	32 mm İzoleli Çelik Spiral Boru	32 mm	36	25
PLN-İZLT-35	35 mm İzoleli Çelik Spiral Boru	35 mm	39	25
PLN-İZLT-37	37 mm İzoleli Çelik Spiral Boru	37 mm	41	25
PLN-İZLT-40	40 mm İzoleli Çelik Spiral Boru	40 mm	44	25
PLN-İZLT-42	42 mm İzoleli Çelik Spiral Boru	42 mm	46	25
PLN-İZLT-45	45 mm İzoleli Çelik Spiral Boru	45 mm	49	25
PLN-İZLT-50	50 mm İzoleli Çelik Spiral Boru	50 mm	54	25

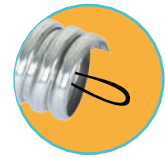

PLASTİK HAFİF SERİ SİYAH SİRİRAL BORU PLASTIC LIGHT SERIES BLACK SİRİRAL PIPE



KOD CODE	ÜRÜN ADI PRODUCT NAME	İÇ ÇAP INSIDE	DIŞ ÇAP OUTSIDE	MT. PACK
PLN-PLS-14	14 mm Plastik Spiral Boru	14	18.1	100
PLN-PLS-16	16 mm Plastik Spiral Boru	16	19.8	100
PLN-PLS-18	18 mm Plastik Spiral Boru	18	22.1	100
PLN-PLS-20	20 mm Plastik Spiral Boru	20	24.2	100
PLN-PLS-25	25 mm Plastik Spiral Boru	25	28.9	100
PLN-PLS-32	32 mm Plastik Spiral Boru	32	36	50

PLASTİK SİYAH HAFİF SERİ SİRİRAL BORU KILAVUZ TELLİ BLACK PVC LIGHT SERIES SİRİRAL PIPE WITH WIRE



KOD CODE	ÜRÜN ADI PRODUCT NAME	İÇ ÇAP INSIDE	DIŞ ÇAP OUTSIDE	MT. PACK
PLN-PLST-14	14 mm Plastik Spiral Boru	14	18.1	100
PLN-PLST-16	16 mm Plastik Spiral Boru	16	19.8	100
PLN-PLST-18	18 mm Plastik Spiral Boru	18	22.1	100
PLN-PLST-20	20 mm Plastik Spiral Boru	20	24.2	100
PLN-PLST-25	25 mm Plastik Spiral Boru	25	28.9	100
PLN-PLST-32	32 mm Plastik Spiral Boru	32	36	50

H. FREE ALEV YAYAN TURUNCU PLASTİK SİRİAL BORU
H. FREE FLAMMABLE ORANGE PLASTIC SPIRAL PIPE

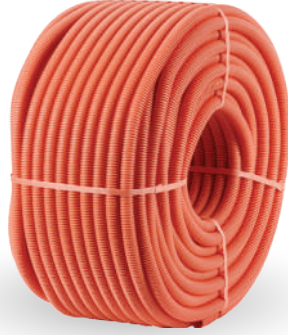

KOD CODE	ÜRÜN ADI PRODUCT NAME	İÇ ÇAP INSIDE	DIŞ ÇAP OUTSIDE	MT. PACK
PLN-PLSH-14	14 mm H. Free Turuncu Spiral Boru	14	18.1	100
PLN-PLSH-16	16 mm H. Free Turuncu Spiral Boru	16	19.8	100
PLN-PLSH-18	18 mm H. Free Turuncu Spiral Boru	18	22.1	100
PLN-PLSH-20	20 mm H. Free Turuncu Spiral Boru	20	24.2	100
PLN-PLSH-25	25 mm H. Free Turuncu Spiral Boru	25	28.9	100
PLN-PLSH-32	32 mm H. Free Turuncu Spiral Boru	32	36	50

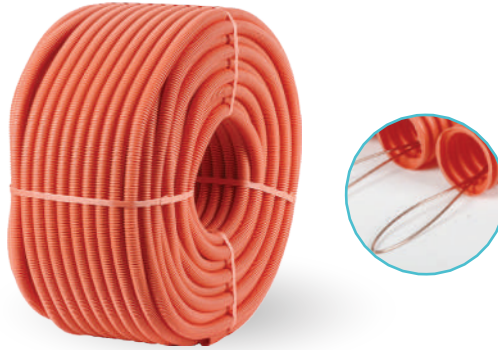

H. FREE ALEV YAYAN TURUNCU PLASTİK SİRİAL BORU KILAVUZ TELLİ
H. FREE FLAMMABLE ORANGE PLASTIC SPIRAL PIPE WITH WIRE

KOD CODE	ÜRÜN ADI PRODUCT NAME	İÇ ÇAP INSIDE	DIŞ ÇAP OUTSIDE	MT. PACK
PLN-PLSHT-14	14 mm H. Free Turuncu Spiral Boru	14	18.1	100
PLN-PLSHT-16	16 mm H. Free Turuncu Spiral Boru	16	19.8	100
PLN-PLSHT-18	18 mm H. Free Turuncu Spiral Boru	18	22.1	100
PLN-PLSHT-20	20 mm H. Free Turuncu Spiral Boru	20	24.2	100
PLN-PLSHT-25	25 mm H. Free Turuncu Spiral Boru	25	28.9	100
PLN-PLSHT-32	32 mm H. Free Turuncu Spiral Boru	32	36	50

POLİETİLEN KANGAL BORULAR (SİYAH)
POLYETHYLENE COIL PIPES (BLACK)



6 ATÜ - 6 ATÜ

ALEV YAYAN

KOD CODE	ÜRÜN ADI PRODUCT NAME	NEWTON	MT. PACK
PLN-KGBS 14	14 mm Polietilen Boru 6 ATÜ	450	100
PLN-KGBS 16	16 mm Polietilen Boru 6 ATÜ	450	100
PLN-KGBS 18	18 mm Polietilen Boru 6 ATÜ	450	100
PLN-KGBS 20	20 mm Polietilen Boru 6 ATÜ	450	100
PLN-KGBS 25	25 mm Polietilen Boru 6 ATÜ	450	100
PLN-KGBS 32	32 mm Polietilen Boru 6 ATÜ	450	50
PLN-KGBS 40	40 mm Polietilen Boru 6 ATÜ	450	50
PLN-KGBS 50	50 mm Polietilen Boru 6 ATÜ	450	50
PLN-KGBS 63	63 mm Polietilen Boru 6 ATÜ	450	50

HALOGEN FREE ALEV YAYAN KANGAL BORULAR (TURUNCU)
HALOGEN FREE COIL PIPES (ORANGE)



6 ATÜ - 6 ATU
HALOGEN FREE
ALEV YAYAN

KOD CODE	ÜRÜN ADI PRODUCT NAME	NEWTON	MT. PACK
PLN-KGBT 14	14 mm Polietilen Boru 6 ATÜ	450	100
PLN-KGBT 16	16 mm Polietilen Boru 6 ATÜ	450	100
PLN-KGBT 18	18 mm Polietilen Boru 6 ATÜ	450	100
PLN-KGBT 20	20 mm Polietilen Boru 6 ATÜ	450	100
PLN-KGBT 25	25 mm Polietilen Boru 6 ATÜ	450	100
PLN-KGBT 32	32 mm Polietilen Boru 6 ATÜ	450	50
PLN-KGBT 40	40 mm Polietilen Boru 6 ATÜ	450	50
PLN-KGBT 50	50 mm Polietilen Boru 6 ATÜ	450	50
PLN-KGBT 63	63 mm Polietilen Boru 6 ATÜ	450	50

Plastik Susta (Takviyeli) Plastic Strina (Consolidated)



KOD CODE	ÜRÜN ÖLÇÜLERİ - SIZE	KOLİ BOX
PLN-PS-5	5 mt plastik susta - 5 mt plastic strina consolidated	40
PLN-PS-10	10 mt plastik susta - 10 mt plastic strina consolidated	25
PLN-PS-15	15 mt plastik susta - 15 mt plastic strina consolidated	20
PLN-PS-20	20 mt plastik susta - 20 mt plastic strina consolidated	15
PLN-PS-25	25 mt plastik susta - 25 mt plastic strina consolidated	13
PLN-PS-30	30 mt plastik susta - 30 mt plastic strina consolidated	10

Çelik Susta Steel Strina



KOD CODE	ÜRÜN ÖLÇÜLERİ - SIZE	KOLİ BOX
PLN-ÇS-5	5 mt çelik susta - 5 mt steel strina	40
PLN-ÇS-10	10 mt çelik susta - 10 mt steel strina	25
PLN-ÇS-15	15 mt çelik susta - 15 mt steel strina	20
PLN-ÇS-20	20 mt çelik susta - 20 mt steel strina	15
PLN-ÇS-25	25 mt çelik susta - 25 mt steel strina	13
PLN-ÇS-30	30 mt çelik susta - 30 mt steel strina	10

Çelik Susta (Takviyeli) Steel Strina (Consolidated)



KOD CODE	ÜRÜN ÖLÇÜLERİ - SIZE	KOLİ BOX
PLN-ÇST-5	5 mt çelik susta - 5 mt steel strina consolidated	40
PLN-ÇST-10	10 mt çelik susta - 10 mt steel strina consolidated	25
PLN-ÇST-15	15 mt çelik susta - 15 mt steel strina consolidated	20
PLN-ÇST-20	20 mt çelik susta - 20 mt steel strina consolidated	15
PLN-ÇST-25	25 mt çelik susta - 25 mt steel strina consolidated	13
PLN-ÇST-30	30 mt çelik susta - 30 mt steel strina consolidated	10

CCA KABLO

MAKARALI UZATMA KABLOSU ROLLER EXTENSION CABLE



KOD CODE	KESİT SIZE	KESİT SECTION	KOLİ İÇİ CTN - PCS
PLN-M	Boş Makara	Boş / Spool Empty	4
PLN-20	20 MT	3 x 1,5 mm ²	2
PLN-35	35 MT	3 x 1,5 mm ²	2
PLN-50	50 MT	3 x 1,5 mm ²	2
PLN-A20	20 MT	3 x 2,5 mm ²	2
PLN-A30	30 MT	3 x 2,5 mm ²	2
PLN-A40	40 MT	3 x 2,5 mm ²	2
PLN-A50	50 MT	3 x 2,5 mm ²	2

ASKI TİJ TAKIMI HANGER ROD SET



KOD CODE	ÜRÜN - PRODUCT	KUTU BOX	KOLİ BOX
PDT01	Aski Tij Takımı	50	300

Çivili Kroşe Concrete Nail Crochet



KOD CODE	ÜRÜN PRODUCT	KOLİ BOX
PLN-Ç-0	0 NO. ÇİVİLİ KROŞE 5 mm	20.000
PLN-Ç-1	1 NO. ÇİVİLİ KROŞE 4 mm	20.000
PLN-Ç-2	2 NO. ÇİVİLİ KROŞE 6 mm	20.000
PLN-Ç-3	3 NO. ÇİVİLİ KROŞE 8 mm	20.000
PLN-Ç-4	4 NO. ÇİVİLİ KROŞE 10 mm	20.000
PLN-Ç-5	5 NO. ÇİVİLİ KROŞE 11 mm	10.000
PLN-Ç-6	6 NO. ÇİVİLİ KROŞE 12 mm	10.000
PLN-Ç-7	7 NO. ÇİVİLİ KROŞE 16 mm	10.000
PLN-Ç-8	8 NO. ÇİVİLİ KROŞE 22 mm	6.000

Dübel Dowel



KOD CODE	ÜRÜN PRODUCT	PAKET PACKAGE	KOLİ BOX
PLN-RL-04	7 mm Dübel	1.000	25.000
PLN-RL-05	8 mm Dübel	1.000	25.000

Kablo Bağı Dübeli Cable Tie Dowel



KOD CODE	ÜRÜN PRODUCT	PAKET PACKAGE	KOLİ BOX
PLN-KB-7	Delikli Duvar Kroşe 7 mm	100	10.000
PLN-KB-8	Kablo Bağı Dübeli 8 mm (Lok Kroşe)	100	5.000
PLN-KB-10	Kablo Bağı Dübeli 10 mm (Lok Kroşe)	100	5.000

20 x 20 x 20

Menhol Underground Junction Box

KOD CODE	ÜRÜN PRODUCT	KOLİ BOX
PLN-MNH-20C	20 x 20 x 20 Menhol Düz Kapaklı-Contalı 20 x 20 x 20 Manhole with Flat Cover-Gasket	1/20

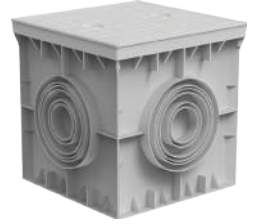
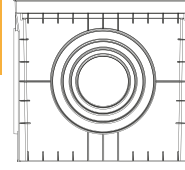

30 x 30 x 30

Menhol Underground Junction Box

KOD CODE	ÜRÜN PRODUCT	KOLİ BOX
PLN-MNH-30C	30 x 30 x 30 Menhol Düz Kapaklı 4 Çıkışlı - Contalı 30 x 30 x 30 Manhole Flat Covered 4 Outlet - With Gasket	4
PLN-MNH-30C6	Menhol 6 Çıkışlı Kapaklı - Contalı Manhole 6 Outlet Covered - Gasketed	4

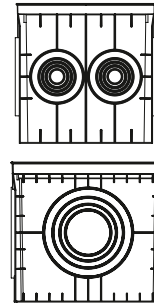

40 x 40 x 40

Menhol Underground Junction Box

KOD CODE	ÜRÜN PRODUCT	KOLİ BOX
PLN-MNH-40C	40 x 40 x 40 Menhol Düz Kapaklı 4 Çıkışlı - Contalı 40 x 40 x 40 Manhole Flat Covered 4 Outlet - With Gasket	2
PLN-MNH-40C6	Menhol 4 Çıkışlı Kapaklı - Contalı Manhole 4 Outlet Covered - Gasketed	2

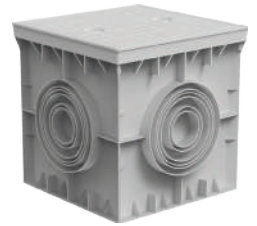
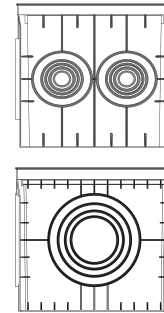

55 x 55 x 50

Menhol Underground Junction Box

KOD CODE	ÜRÜN PRODUCT	KOLİ BOX
PLN-MNH-50C	55 x 55 x 50 Menhol Düz Kapaklı 4 Çıkışlı - Contalı 55 x 55 x 50 Manhole Flat Covered 4 Outlet - With Gasket	1
PLN-MNH-50C6	Menhol 10 Çıkışlı Kapaklı - Contalı Manhole 10 Outlet Covered - Gasketed	1

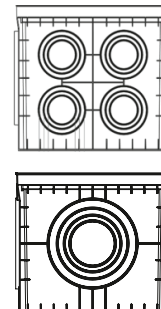

LIGHTING

AYDINLATMA



TAVAN ARMATÜRLERİ PLASTİK CEILING FIXTURE PLASTIC

Hareket Sensörlü / plastik taban + pc kapak

PLNPT01



PLNPT02



ACİL KİTLİ

Lamba Tipi-LampType 2xE27
Güç-Power MAX: 9W(LED bulb)/25W (CFL bulb)
Voltaj-Operating Voltage AC 175-240V 50/60 Hz
Çalışma Sıcaklığı-Operating Temperature -25 + 40°C
Koruma Sınıfı-IP Protection IP20

Lamba Tipi-LampType 2xE27 Emergency Kit
Güç-Power MAX: 9W(LED bulb)/25W (CFL bulb)
Voltaj-Operating Voltage AC 175-240V 50/60 Hz
Çalışma Sıcaklığı-Operating Temperature -25 + 40°C
Koruma Sınıfı-IP Protection IP20

Ölçü-Dimensions: 295x100 mm

Ölçü-Dimensions: 295x100 mm



PLNPT03



PLNPT04



LEDLİ
ACİL KİTLİ

Lamba Tipi-LampType LEDLİ
Güç-Power 15W
Renk-Color Temperature 6500K / 3200K
Lümen-Light Efficiency 1200 Lümen
Voltaj-Operating Voltage AC 175-240V 50/60 Hz
Çalışma Sıcaklığı-Operating Temperature -25 + 40°C
Ömrü-Rated lifespan 25.000 Hours
Koruma Sınıfı-IP Protection IP20

Lamba Tipi-LampType LED +3W LED Emergency Kit
Güç-Power 15W
Renk-Color Temperature 6500K / 3200K
Lümen-Light Efficiency 1200 Lümen
Voltaj-Operating Voltage AC 175-240V 50/60 Hz
Çalışma Sıcaklığı-Operating Temperature -25 + 40°C
Ömrü-Rated lifespan 25.000 Hours
Koruma Sınıfı-IP Protection IP20

Ölçü-Dimensions: 295x100 mm

Ölçü-Dimensions: 295x100 mm



TAVAN ARMATÜRLERİ CAM CEILING FIXTURE GLASS

Hareket Sensörlü / metal taban + cam kapak

PLNMT01



Lamba Tipi-LampType	2xE27
Güç-Power	MAX: 9W(LED bulb)/25W (CFL bulb)
Voltaj-Operating Voltage	AC 175-240V 50/60 Hz
Çalışma Sıcaklığı-Operating Temperature	-25 + 40°C
Koruma Sınıfı-IP Protection	IP20
Ölçü-Dimensions:	295x100 mm



PLNMT02



ACİL KİTLİ

Lamba Tipi-LampType	2xE27 + 3W LED Emergency Kit
Güç-Power	MAX: 9W(LED bulb)/25W (CFL bulb)
Renk-Color Temperature	-
Lümen-Light Efficiency	-
Voltaj-Operating Voltage	AC 175-240V 50/60 Hz
Çalışma Sıcaklığı-Operating Temperature	-25 + 40°C
Ömrü-Rated lifespan	-
Koruma Sınıfı-IP Protection	IP20
Ölçü-Dimensions:	295x100 mm



PLNMT03



Lamba Tipi-LampType	LEDLİ
Güç-Power	15W
Renk-Color Temperature	6500K / 3200K
Lümen-Light Efficiency	1200 Lümen
Voltaj-Operating Voltage	AC 175-240V 50/60 Hz
Çalışma Sıcaklığı-Operating Temperature	-25 + 40°C
Ömrü-Rated lifespan	25,000 Hours
Koruma Sınıfı-IP Protection	IP20
Ölçü-Dimensions:	295x100 mm



PLNMT04



LEDLİ
ACİL KİTLİ

Lamba Tipi-LampType	LED +3W LED Emergency Kit
Güç-Power	15W
Renk-Color Temperature	6500K / 3200K
Lümen-Light Efficiency	1200 Lümen
Voltaj-Operating Voltage	AC 175-240V 50/60 Hz
Çalışma Sıcaklığı-Operating Temperature	-25 + 40°C
Ömrü-Rated lifespan	25,000 Hours
Koruma Sınıfı-IP Protection	IP20
Ölçü-Dimensions:	295x100 mm



LED MERDİVEN SPOTLARI LED STAIR SPOTLIGHT

PLNX0



Güç-Power	3W
Renk-Color Temperature	6500K / 3200K 6 / B
Lümen-Light Efficiency	250 Lümen
Voltaj-Operating Voltage	AC 175-240V 50/60 Hz
Çalışma Sıcaklığı-Operating Temperature	-25 + 40°C
Ömrü-Rated lifespan	25.000 Hours
Koruma Sınıfı-IP Protection	IP20

Ölçü-Dimensions: 80x40 mm



PLNX1



Güç-Power	3W
Renk-Color Temperature	6500K / 3200K 6 / B
Lümen-Light Efficiency	250 Lümen
Voltaj-Operating Voltage	AC 175-240V 50/60 Hz
Çalışma Sıcaklığı-Operating Temperature	-25 + 40°C
Ömrü-Rated lifespan	25.000 Hours
Koruma Sınıfı-IP Protection	IP20

Ölçü-Dimensions: 80x40 mm



PLNX2



Güç-Power	3W
Renk-Color Temperature	6500K / 3200K 6 / B
Lümen-Light Efficiency	250 Lümen
Voltaj-Operating Voltage	AC 175-240V 50/60 Hz
Çalışma Sıcaklığı-Operating Temperature	-25 + 40°C
Ömrü-Rated lifespan	25.000 Hours
Koruma Sınıfı-IP Protection	IP20

Ölçü-Dimensions: 110 x 110 x 40 mm



PLNX3



Güç-Power	3W
Renk-Color Temperature	6500K / 3200K 6 / B
Lümen-Light Efficiency	250 Lümen
Voltaj-Operating Voltage	AC 175-240V 50/60 Hz
Çalışma Sıcaklığı-Operating Temperature	-25 + 40°C
Ömrü-Rated lifespan	25.000 Hours
Koruma Sınıfı-IP Protection	IP20

Ölçü-Dimensions: 110 x 110 x 40 mm



ETANJ ARMATÜRLER WATERLIGHT ARMATURE

IP 65



Lamba Tipi-LampType	2xT8
Güç-Power	MAX: 9W(LED bulb)/18W (CFL bulb)
Voltaj-Operating Voltage	AC 175-240V 80/60 Hz
Çalışma Sıcaklığı-Operating Temperature	-25 + 40°C
Koruma Sınıfı-IP Protection	IP65

Ölçü-Dimensions: 665 x 120 x 100 mm

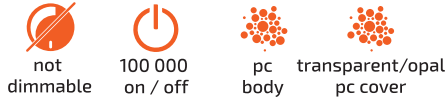

Lamba Tipi-LampType	2xT8
Güç-Power	MAX: 9W(LED bulb)/36W (CFL bulb)
Voltaj-Operating Voltage	AC 175-240V 80/60 Hz
Çalışma Sıcaklığı-Operating Temperature	-25 + 40°C
Koruma Sınıfı-IP Protection	IP65

Ölçü-Dimensions: 1.275 x 120 x 100 mm

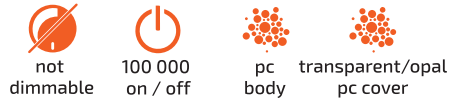

499: 6500K
500: 4000K
501: 3200K

Lamba Tipi-LampType	SMD LED
Güç-Power	40W
Renk-Color Temperature	6500K / 4000K / 3200K
Lümen-Light Efficiency	3600 Lümen
Voltaj-Operating Voltage	AC 175-240V 50/60 Hz
Çalışma Sıcaklığı-Operating Temperature	-25 + 40°C
Ömrü-Rated lifespan	35.000 Hours
Koruma Sınıfı-IP Protection	IP65

Ölçü-Dimensions: 1.275 x 120 x 100 mm



ETANJ ARMATÜRLER WATERLIGHT ARMATURE

IP 65

502: 6500K
503: 4000K
504: 3200K



Lamba Tipi-LampType SMD Mid Power LED
Güç-Power 20W
Renk-Color Temperature 6500K / 4000K / 3200K
Lümen-Light Efficiency 2000 Lümen
Voltaj-Operating Voltage AC 175-240V 50/60 Hz
Çalışma Sıcaklığı-Operating Temperature -25 + 40°C
Ömrü-Rated lifespan 50.000 Hours
Koruma Sınıfı-IP Protection IP65
Ölçü-Dimensions: 600 mm

 not dimmable
 100 000 on / off
 pc body & cover

505: 6500K
506: 4000K
507: 3200K



Lamba Tipi-LampType SMD Mid Power LED
Güç-Power 40W
Renk-Color Temperature 6500K / 4000K / 3200K
Lümen-Light Efficiency 4000 Lümen
Voltaj-Operating Voltage AC 175-240V 50/60 Hz
Çalışma Sıcaklığı-Operating Temperature -25 + 40°C
Ömrü-Rated lifespan 50.000 Hours
Koruma Sınıfı-IP Protection IP65
Ölçü-Dimensions: 1.200 mm

 not dimmable
 100 000 on / off
 pc body & cover

508: 6500K
509: 4000K
510: 3200K



Lamba Tipi-LampType SMD Mid Power LED
Güç-Power 80W
Renk-Color Temperature 6500K / 4000K / 3200K
Lümen-Light Efficiency 8000 Lümen
Voltaj-Operating Voltage AC 175-240V 50/60 Hz
Çalışma Sıcaklığı-Operating Temperature -25 + 40°C
Ömrü-Rated lifespan 50.000 Hours
Koruma Sınıfı-IP Protection IP65
Ölçü-Dimensions: 1.200 mm

 not dimmable
 100 000 on / off
 pc body & cover

526: 6500K
527: 4000K
528: 3200K



Lamba Tipi-LampType SMD Mid Power LED
Güç-Power 120W
Renk-Color Temperature 6500K / 4000K / 3200K
Lümen-Light Efficiency 12000 Lümen
Voltaj-Operating Voltage AC 175-240V 50/60 Hz
Çalışma Sıcaklığı-Operating Temperature -25 + 40°C
Ömrü-Rated lifespan 50.000 Hours
Koruma Sınıfı-IP Protection IP65
Ölçü-Dimensions: 1.200 mm

 not dimmable
 100 000 on / off
 pc body & cover

LED WALLWASHER LED WALLWASHER

IP 65

027: 6500K 026:G
029: 4000K 031:B
028: 3200K 032:A
030: R



034: 6500K 026:G
036: 4000K 031:B
035: 3200K 032:A
037: R



Lamba Tipi-LampType 3030 SMD LED
Güç-Power 3W
Renk-Color Temperature 6500K / 4000K / 3200K
Length 10 cm
Voltaj-Operating Voltage AC 175-240V 50/60 Hz
Çalışma Sıcaklığı-Operating Temperature -25 + 40°C
Ömrü-Rated lifespan 25.000 Hours
Koruma Sınıfı-IP Protection IP65
Ölçü-Dimensions: 100 mm

Lamba Tipi-LampType 3030 SMD LED
Güç-Power 6W
Renk-Color Temperature 6500K / 4000K / 3200K
Length 20 cm
Voltaj-Operating Voltage AC 175-240V 50/60 Hz
Çalışma Sıcaklığı-Operating Temperature -25 + 40°C
Ömrü-Rated lifespan 25.000 Hours
Koruma Sınıfı-IP Protection IP65
Ölçü-Dimensions: 200 mm



001: 6500K 006:G
042: 4000K 003:B
002: 3200K 006:A
004: R 007:R



Lamba Tipi-LampType 3030 SMD LED
Güç-Power 9W
Renk-Color Temperature 6500K / 4000K / 3200K
Length 30 cm
Voltaj-Operating Voltage AC 175-240V 50/60 Hz
Çalışma Sıcaklığı-Operating Temperature -25 + 40°C
Ömrü-Rated lifespan 25.000 Hours
Koruma Sınıfı-IP Protection IP65
Ölçü-Dimensions: 300 mm



LED WALLWASHER LED WALLWASHER

IP 65



043: 6500K 047:G
045: 4000K 048:B
044: 3200K 049:A
046: R 050: 

Lamba Tipi-LampType 3030 SMD LED
Güç-Power 12W
Renk-Color Temperature 6500K / 4000K / 3200K
Length 35 cm
Voltaj-Operating Voltage AC 175-240V 50/60 Hz
Çalışma Sıcaklığı-Operating Temperature -25 + 40°C
Ömrü-Rated lifespan 25.000 Hours
Koruma Sınıfı-IP Protection IP65

Ölçü-Dimensions: 350 mm

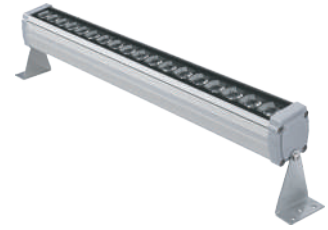

010: 6500K 014:G
051: 4000K 012:B
011: 3200K 015:A
013: R 016: 

Lamba Tipi-LampType 3030 SMD LED
Güç-Power 18W
Renk-Color Temperature 6500K / 4000K / 3200K
Length 50 cm
Voltaj-Operating Voltage AC 175-240V 50/60 Hz
Çalışma Sıcaklığı-Operating Temperature -25 + 40°C
Ömrü-Rated lifespan 25.000 Hours
Koruma Sınıfı-IP Protection IP65

Ölçü-Dimensions: 500 mm

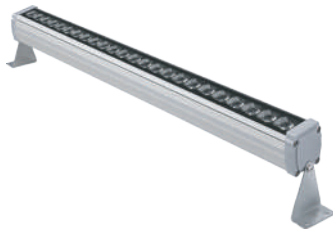

052: 6500K 056:G
054: 4000K 057:B
053: 3200K 058:A
055: R 059: 

Lamba Tipi-LampType 3030 SMD LED
Güç-Power 24W
Renk-Color Temperature 6500K / 4000K / 3200K
Length 70 cm
Voltaj-Operating Voltage AC 175-240V 50/60 Hz
Çalışma Sıcaklığı-Operating Temperature -25 + 40°C
Ömrü-Rated lifespan 25.000 Hours
Koruma Sınıfı-IP Protection IP65

Ölçü-Dimensions: 700 mm



060: 6500K 064:G
062: 4000K 065:B
061: 3200K 025:A
063: R 066: 

Lamba Tipi-LampType 3030 SMD LED
Güç-Power 36W
Renk-Color Temperature 6500K / 4000K / 3200K
Length 100 cm
Voltaj-Operating Voltage AC 175-240V 50/60 Hz
Çalışma Sıcaklığı-Operating Temperature -25 + 40°C
Ömrü-Rated lifespan 25.000 Hours
Koruma Sınıfı-IP Protection IP65

Ölçü-Dimensions: 1.000 mm





2'li Dönüş - 2 Gang Turn

Ürün Kodu - Product Code

PLN-245

Paket İçi Adet - Pcs in Package

60

Fiyat Adet - Price PCS



45°

2'li Dönüş - 2 Gang Turn

Ürün Kodu - Product Code

PLN-290

Paket İçi Adet - Pcs in Package

50

Fiyat Adet - Price PCS



90°



3'lü Dönüş - 3 Gang Turn



Ürün Kodu - Product Code

PLN-345

Paket İçi Adet - Pcs in Package

60

Fiyat Adet - Price PCS

45°



3'lü Dönüş - 3 Gang Turn



Ürün Kodu - Product Code

PLN-390

Paket İçi Adet - Pcs in Package

50

Fiyat Adet - Price PCS

90°



4'lü Dönüş - 4 Gang Turn



Ürün Kodu - Product Code

PLN-490

Paket İçi Adet - Pcs in Package

30

Fiyat Adet - Price PCS

90°



2'li Final - 2 Gang Final



Ürün Kodu - Product Code

PLN-2F

Paket İçi Adet - Pcs in Package

60

Fiyat Adet - Price PCS



3'lü Final - 3 Gang Final



Ürün Kodu - Product Code

PLN-3F

Paket İçi Adet - Pcs in Package

60

Fiyat Adet - Price PCS



4'lü Final - 4 Gang Final



Ürün Kodu - Product Code

PLN-4F

Paket İçi Adet - Pcs in Package

60

Fiyat Adet - Price PCS



2'li Ek - 2 Gang Add

Ürün Kodu - Product Code

PLN-2E

Paket İçi Adet - Pcs in Package

60

Fiyat Adet - Price PCS



3'lü Ek - 3 Gang Add

Ürün Kodu - Product Code

PLN-3E

Paket İçi Adet - Pcs in Package

60

Fiyat Adet - Price PCS

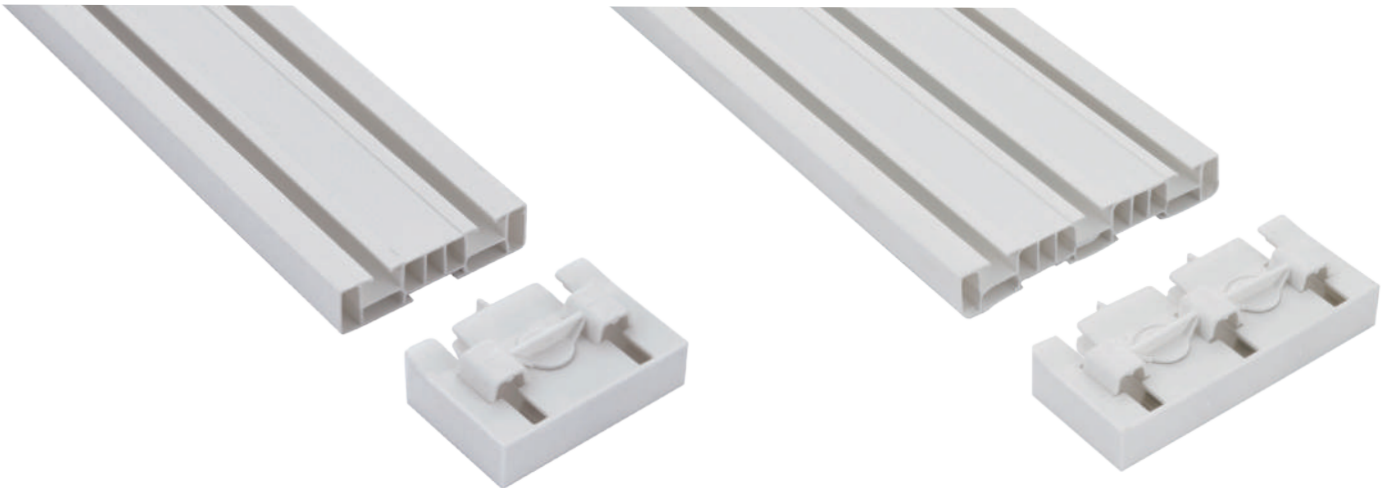
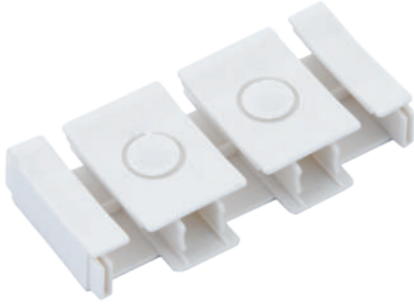

Kilitli Rulet - Plug-Roulette



Ürün Kodu - Product Code PLN-RL-01

Kutu - Box 1000

Fiyat Paket - Price Pack

Final Stop - Final Stop



Ürün Kodu - Product Code PLN-RL-03

Kutu - Box 1000

Fiyat Paket - Price Pack

L Profil - L Profile

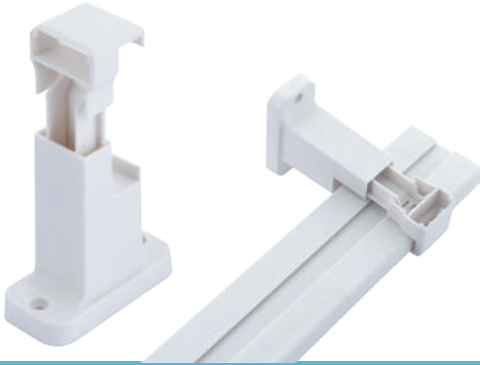

Ürün Kodu - Product Code PLN-L

Kutu - Box 60

Fiyat Adet - Price PCS

Çivili Dübel - Spiked Peg

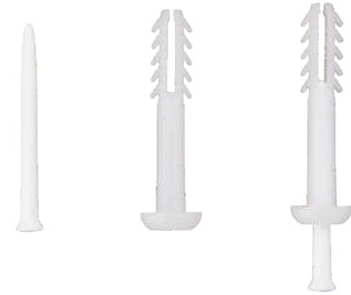

Ürün Kodu - Product Code PLN-RL-02

Kutu - Box 500

Fiyat Paket - Price Pack

2'li Korniş Kapağı - 2 Cornice Covers



Ürün Kodu - Product Code PLN-KRNS-02

Kutu - Box 500

Fiyat Paket - Price Pack

3'lü Korniş Kapağı - 3 Cornice Covers



Ürün Kodu - Product Code PLN-KRNS-03

Kutu - Box 500

Fiyat Paket - Price Pack



TÜRK STANDARDLARI ENSTİTÜSÜ
DENEY ve KALİBRASYON
MERKEZİ BAŞKANLIĞI
ELEKTROTEKNİK LABORATUVARI ANKARA
MÜDÜRLÜĞÜ

TURKISH STANDARDS INSTITUTION
HEADSHIP OF TSE TEST and CALIBRATION CENTER
Electrotechnical Laboratory Ankara

Necatbey Cad. No:112 Bakanlık / ANKARA / TÜRKİYE

Tel: 0312 416 6553 Faks: e-mail: elektrotekniklabankara@tse.org.tr

www.tse.org.tr

136408

05-23

MUAYENE VE DENEY RAPORU
TEST REPORT

Deneyi Talep Eden/Firma : <i>(Adı, Adresi, Şehir vb.)</i> <i>Requesting/Customer (Name, Address, City etc.)</i>	PLANET PLASTİK ELEKTRİK SANAYİ VE DİŞ TİCARET ANONİM ŞİRKETİ
Deney Talep Tarihi / No : <i>Order Date/No.</i>	17.04.2023 / 2023-85426
Numunenin Tanımı : <i>(Çins, Marka, Sınıf, Tip, Tür, Model vb.)</i> <i>Sample Description (Type, Mark, Class, Model etc.)</i>	2023-123586. PVC KABLO KANALI, PLANET PLASTİK ELEKTRİK, 40X40, PROFİL, KABLO KANALI, BEYAZ RENK, 1.00, metre
Numune Kabul Tarihi : <i>Sample Receipt Date</i>	27.04.2023
Deneylerin Yapıldığı Tarih : <i>Date of Test</i>	28.04.2023 / 03.05.2023
Uygulanan Standart Metot : <i>Applied Standard/Method</i>	Özel Deney (Borular-Buatlar-Kutular)(İç Tesisit)
Raporun Sayfa Sayısı : <i>Number of pages of the report</i>	3
Deney Sonucu : <i>Test Result</i>	-
Açıklamalar : <i>Remarks</i>	Özel Deney

Yukarıda tanımlanan numune için laboratuvarımızda yapılan muayene ve deneylerden elde edilen sonuçlar müteakip sayfalarda verilmiştir.
The testing and/or measurement results are given on the following pages which are part of this report.

Karekod <i>QR Code</i>	Tarih <i>Date</i>	Deney Sorumlusu <i>Person in charge of test</i>	Kontrol Eden <i>Reviewer</i>	Onaylayan <i>Head of Laboratory</i>
	03.05.2023	AHMET NEDİM DOĞAN	BERTAN KAHRAMAN	MUHAMMED HÜSEYİN ALKAN

Bu rapor, hazırlayan laboratuvarın yazılı izni olmadan kısmen kopyalanıp çoğaltılamaz. İmzasız ve karekodsuz raporlar geçersizdir. Bu rapor, sadece deneyi yapılan numune için geçerlidir ve "Ürün Belgesi" yerine geçmez.
This test report shall not be reproduced other than in full except with the written permission of the laboratory. Test reports without signature and seal are not valid. This test report represents only tested sample(s), and shall not be used as Product Certificate.

Bu doküman elektronik ortamda imzalanmıştır.

Doğrulama adresi: <https://basvuru.tse.org.tr/uye/QRKodDogrulama?code=D9AA2B>



Sertifika Certificate

PLANET PLASTİK ELEKTRİK SANAYİ VE DİŞ TİCARET ANONİM ŞİRKETİ

İSBB MH. ESKİ TURGUT ÖZAL CD. ALTINTAÇ İŞ MRKZ. NO:3404 BAŞAKŞEHİR / İSTANBUL

DSR BELGELENDİRME tarafından denetlenmiş ve uygulamakta olduğu
Kalite Yönetim Sisteminin

is audited by DSR Certification and applied
Quality Management System meet the requirements of

ISO 9001:2015

standartına aşağıdaki kapsamda uymakta olduğu gözlemlenmiştir.
standard for the following activities.

PVC KABLO KANALI VE AKSESUARLARI, PLASTİK SİRAL, ÇELİK VE İZOLELİ SİRAL BORU
İMALATI, PVC RÜJİT BORULAR, ABS PANO VE TERMOPLASTİK BUALAR, BANYO ASPİRATÖRLERİ,
KABLO BAĞI, KABLO MAKARASI, MENHOL, AYDINLATMA VE PLASTİK ÇELİK SUSTALAR, SİGORTA
KUTUSU, GRUP PRİZ VE AKSESUARLARI VB. ELEKTRİK MALZEMELERİ SATIŞI

PVC CABLE TRUNKINGS AND ACCESSORIES, PLASTIC SPIRAL, STEEL AND INSULATED STEEL SPIRAL
MANUFACTURING, PVC RIGID PIPES, ABS PANEL BOARD AND THERMOPLASTIC JUNCTION BOXES,
ASPIRATORS, CABLE TIES, CABLE REEL, MENHOLE PLASTIC AND STEEL GUIDES, FUSE BOXES, GROUP
SOCKETS AND ACCESSORIES, AND SELLING OF OTHER ELECTRICAL MATERIALS.

Sertifika No / Certificate No: QMS-23.04.311

06.04.2023
Sertifika Tarihi
Certificate Date

06.04.2023
Sertifika Son Basmı Tarihi
Certificate Last Issue Date

05.04.2024
Sertifika Geçerlik Tarihi
Certificate Expiry Date

3 Yıl / Years
Belgelendirme Periyodu
Certification Period

EA Kodu/EA Code: 29



DSR TEKNİK MUAYENE SERTİFİKASYON HİZ. LTD. ŞTİ.
Yenişehir Mah. Selviölü Sk. Heliç Beyaz Ofis 2/1 A Blok No:297 PENDİK / İSTANBUL / TÜRKİYE Tel: +90 216 806 00 25
E-mail: info@dsrbelgelendirme.com.tr - Web: www.dsrbelgelendirme.com.tr

EU DECLARATION OF CONFORMITY

AB UYGUNLUK BEYANI

Manufacturer name
Üretici adı
Manufacturer address
Üretici adresi

PLANET PLASTİK ELEKTRİK SANAYİ VE DIŞ TİCARET ANONİM ŞİRKETİ
İosb Mh. Eski Turgut Özal Cd. Altınış İş Mrkz. No.8/404
Başakşehir İstanbul Turkey

Product specification
Ürün tanımlaması

Cable trunking systems and cable ducting systems for electrical installations
Elektrik tesisatı için kablo kanal sistemleri ve kablo kanal sistemleri

Types
Tipler

CLOSED TYPE CABLE TRUNKINGS
KAPALI TİP KABLO KANALLARI
INSIDE COVER CABLE TRUNKING AND ACCESSORIES
İÇTEN KAPAKLI KABLO KANALI VE AKSESUARLARI
SELF ADHESIVE CABLE TRUNKINGS
YAPIŞKAN BANTLI KABLO KANALLARI
OVERFLOOR PVC CABLE TRUNKINGS GREY
ZEMİN ÜSTÜ (BALIK SIRT) PVC KABLO KANALLARI GRİ
PVC SLOTTED CABLE TRUNKINGS GREY
DELİKLİ (PANO TİPİ) PVC KABLO KANALLARI GRİ

Trade name(s)
Marka adları



European directive(s)
İlgili AT direktifleri

Low Voltage Equipment Directive (2014/35/EU)
Belirli Gerilim Sınırları İçin Tasarlanan Elektrikli Ekipman İle İlgili Yönetmelik (2014/35/AB)

European standart(s)
İlgili AT standartlar

EN 50085-1:2005+A1:2013
EN 50085-2-1:2006+A1:2011
EN 50085-2-3:2010

This declaration of conformity is issued under the sole responsibility of the manufacturer.
Bu uygunluk deklarasyonu üreticinin kendi sorumluluğunda düzenlenmiştir.

The object of the declaration described above is in conformity with the relevant European Union harmonization legislation:
Yukarıda açıklanan deklarasyonun amacı, ilgili Avrupa Birliği uyum mevzuatı ile uygun olduğudur

Signed for and on behalf of the PLANET PLASTİK ELEKTRİK SANAYİ VE DIŞ TİCARET ANONİM ŞİRKETİ
PLANET PLASTİK ELEKTRİK SANAYİ VE DIŞ TİCARET ANONİM ŞİRKETİ adına
Signature
İmza

Name, Function (İsim, Görevi): Caner Can, General Manager (Genel müdür)
Place of issue (Yayınlanma yeri): İstanbul – Turkey
Date of issue (Yayınlanma tarihi): 1.05.2023



EU DECLARATION OF CONFORMITY

AB UYGUNLUK BEYANI

Manufacturer name
Üretici adı
Manufacturer address
Üretici adresi

PLANET PLASTİK ELEKTRİK SANAYİ VE DIŞ TİCARET ANONİM ŞİRKETİ
İosb Mh. Eski Turgut Özal Cd. Altınış İş Mrkz. No.8/404
Başakşehir İstanbul Turkey

Product specification
Ürün tanımlaması

FLEXIBLE CONDUIT SYSTEMS
BÜKÜLGEN BORU SİSTEMLERİ

Types
Tipler

PLASTIC
PLASTİK

Trade name(s)
Marka adları



European directive(s)
İlgili AT direktifleri

Low Voltage Equipment Directive (2014/35/EU)
Belirli Gerilim Sınırları İçin Tasarlanan Elektrikli Ekipman İle İlgili Yönetmelik (2014/35/AB)

European standart(s)
İlgili AT standartlar

EN 61386-1:2008+A1:2019
EN 61386-23:2004+A11:2010

This declaration of conformity is issued under the sole responsibility of the manufacturer.
Bu uygunluk deklarasyonu üreticinin kendi sorumluluğunda düzenlenmiştir.

The object of the declaration described above is in conformity with the relevant European Union harmonization legislation:
Yukarıda açıklanan deklarasyonun amacı, ilgili Avrupa Birliği uyum mevzuatı ile uygun olduğudur

Signed for and on behalf of the PLANET PLASTİK ELEKTRİK SANAYİ VE DIŞ TİCARET ANONİM ŞİRKETİ
PLANET PLASTİK ELEKTRİK SANAYİ VE DIŞ TİCARET ANONİM ŞİRKETİ adına
Signature
İmza

Name, Function (İsim, Görevi): Caner Can, General Manager (Genel müdür)
Place of issue (Yayınlanma yeri): İstanbul – Turkey
Date of issue (Yayınlanma tarihi): 1.05.2023





Fabrika - Factory

İkitelli OSB Mah. Eski Turgut Özal Cad.
Altıntaş İş Merkezi. D BLOK No:8 3/303
Başakşehir/İstanbul, Türkiye

+90 212 436 46 46

info@planetelektrik.com.tr

www.planetelektrik.com.tr